

# INFORMATION IS KNOWLEDGE IS POWER

**Kaman's On-Site Seminars  
give you valuable information  
on precision position measuring.**



# FEEL THE POWER

Kaman offers flexible, on-site, content-rich seminars that cover inductive displacement sensing technology and applications.

You'll receive new information to bring you greater sensing knowledge and more power over your application.

## KAMAN

By phone:  
800 552-6267

By e-mail:  
[measuring@kaman.com](mailto:measuring@kaman.com)

There is no one ideal technology for position sensing. To select the best technology for a given application, it is necessary to understand the pros and cons of different technologies. We'll cover this and more in Kaman's on-site technology seminars.

### WHY KAMAN

Kaman is recognized worldwide as the leader in the design and application of inductive technology for noncontact displacement sensing. We have been servicing commercial industries and defense programs for over 40 years, with both quality products and unsurpassed knowledge.

### WHY OFFER TRAINING

It is very apparent that the best customers are knowledgeable customers. With that in mind, Kaman has been providing no-cost training seminars to both private and government organizations for over 20 years. These in-depth seminars let you know first hand what inductive 'eddy current' sensing can do for your application. We conduct our seminars at your facility, when convenient, and can do it brown bag style or cater in lunch for small groups.

### WHAT WE DO

1. Set a time and place, typically on site at your facility.
2. Review your content options.
3. Provide a seminar outline to distribute to attendees.

### HOW TO GET STARTED

Contact your Kaman Regional Sales Manager to set up a training seminar for your organization.



## WHAT WE COVER

Kaman offers standard training programs covering the basics of inductive technology. Or we can customize a presentation for you to fit your application.

## TECHNOLOGY

- Inductive basics
- Types of circuits
- Sensor design
- Pros and cons
- Calibration

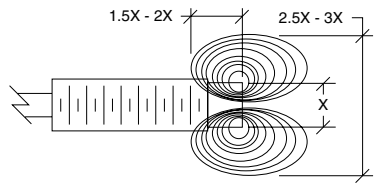

## APPLICATIONS

- Target characteristics
- Environmental considerations
- Sensor mounting
- Cable length
- Sensor selection

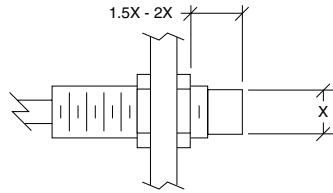

## PERFORMANCE

- Output options
- Error sources
- Frequency response
- Calibration options

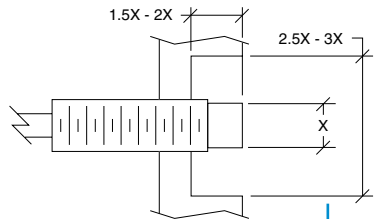

*Mounting considerations*

## Inductive bridge technology

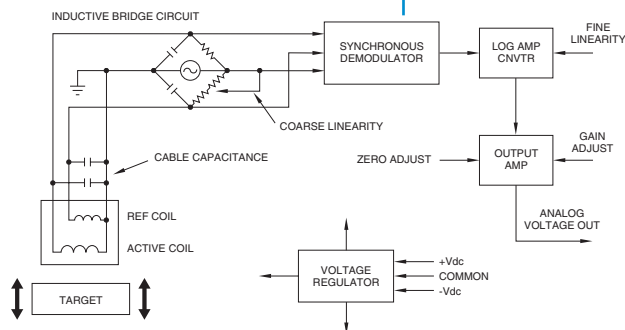

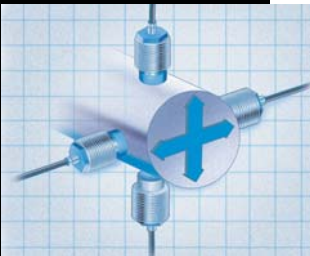
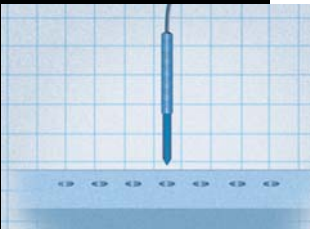
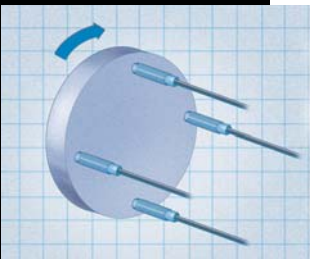
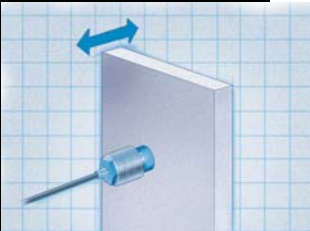
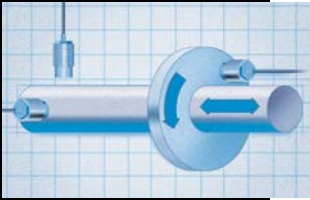
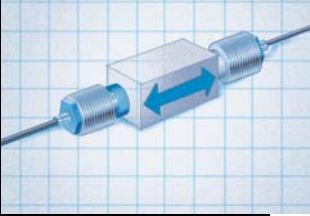

## Kaman's applications define the power of precision position sensing

**DISPLACEMENT** robot repeatability | valve position | artificial heart diaphragm position | servo positioning | disc drive head flying height | oil film thickness | robotic welding servo position feedback | pulp paper refiner control feedback | turbine blade tip clearance | fuel injector needle lift | valve bounce | engrave head feedback | molten metal level | structural movement.

**VIBRATION** rotating shaft | ultrasonic weld horn | uranium enrichment centrifuge | dental drill | silicon wafer slicing blade | disc drive | transmission coupling | centrifugal pump | loudspeaker cone | gas turbine shaft | structural | servo valve.

**ALIGNMENT** mirror stabilization | fast steering mirrors | tensile testing | sounding rocket image trackers | seam tracking | magnetic bearing suspension | shaft alignment | mask alignment | parts positioning | sheet metal edge detection | die and ram alignment.

**DIMENSIONING** thickness | OD | ID | concentricity | straightness | flatness | insulation thickness | printer in cartridge foam thickness | copper clad PCB thickness | strip steel thickness.

**SORTING** multiple category sorting | metallic parts gauging | in-cage ball bearing presence | ceramic capacitor position | drill bit diameter sorting | multiple strand wire inspection.

